

ULTRA MINIATURE CERAMIC PACKAGE HIGH STABILITY SMD CRYSTAL



3.2 x 2.5 x 0.6mm

ABM8X

RoHS/RoHS II Compliant

Moisture Sensitivity Level (MSL) – This product is Hermetically Sealed and not Moisture Sensitive - MSL = N/A: Not Applicable

FEATURES:

- -40°C to +125°C wide operating temperature range
- ±40 ppm Max. All Inclusive frequency stability over 10-year product life
- Fundamental Mode, low ESR Quartz design
- Ultra miniature, Seam-Sealed, RoHS compliant reflow-able package

APPLICATIONS:

- Zigbee based designs for indoor / outdoor applications
- Wireless Sensor Networks
- Industrial Control
- Home and Building Automation
- Consumer Electronics
- PC Peripherals

STANDARD SPECIFICATIONS

Parameters	Minimum	Typical	Maximum	Units	Notes
Center Frequency		24.000 32.000		MHz	
Operation Mode	Fundamental				
Operating Temperature	-40		+125	°C	
Storage Temperature	-55		+155	°C	
Overall Frequency Stability (All inclusive)	-40		+40	ppm	
Frequency Tolerance	-10		+10	ppm	
Frequency Stability over the Operating Temperature Range (ref. to +25°C)	-25		+25	ppm	
Aging	-5		+5	ppm	@25±3°C 10 years
Equivalent series resistance (R1)			60	Ω	
Shunt capacitance (C0)			2.5	pF	
Motional capacitance (C1)		2.0		fF	
Load capacitance (CL)		10		pF	
Drive Level		50	100	μW	
Insulation Resistance	500			MΩ	@100Vdc±15V

Options and Part Identification (left blank if standard)

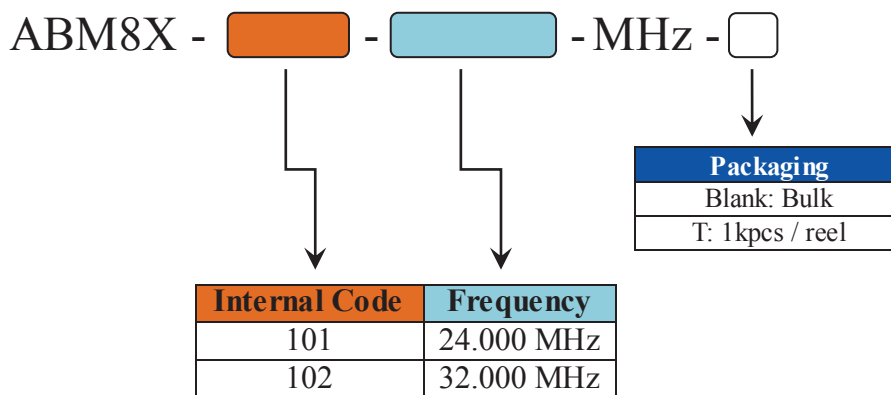

Example Part #: ABM8X-101-24.000MHz-T

ULTRA MINIATURE CERAMIC PACKAGE HIGH STABILITY SMD CRYSTAL



3.2 x 2.5 x 0.6mm

ABM8X

RoHS/RoHS II Compliant

OUTLINE DIMENSIONS:

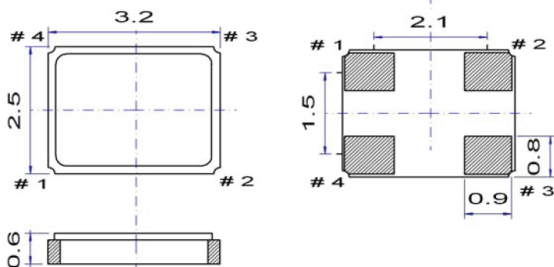

Pin function

- # 1 crystal connection
- # 2 GND
- # 3 crystal connection
- # 4 GND

Top view

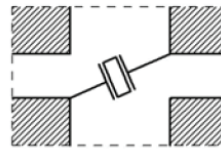

Pad #2 & #4 connected with the metal cap

Do not design any conductive path between the pattern

Example for solder pattern

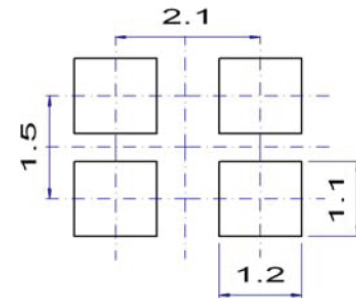

Dimensions: mm

REFLOW PROFILE:

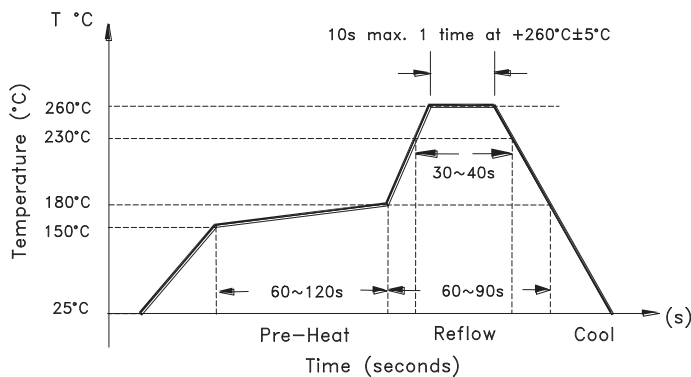

TAPE & REEL:

1000pcs/reel

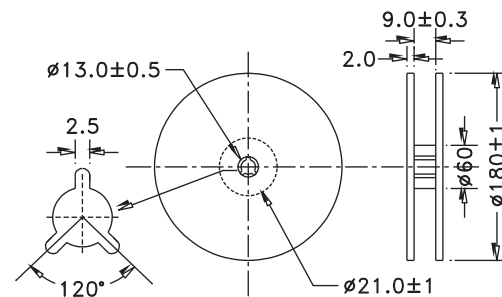
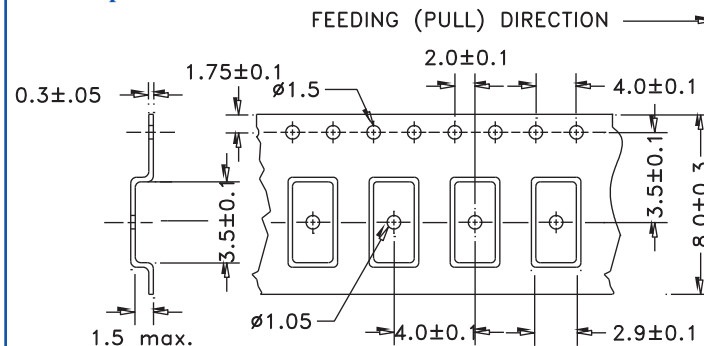

Dimensions: mm



Need a test socket for the ABM8X Series? To view compatible **PRECISION TEST & BURN-IN SOCKETS** for these parts, [click here](#). P/N **AXS-3225-04-01**

ATTENTION: Abracon Corporation's products are COTS – Commercial-Off-The-Shelf products; suitable for Commercial, Industrial and, where designated, Automotive Applications. Abracon's products are not specifically designed for Military, Aviation, Aerospace, Life-dependant Medical applications or any application requiring high reliability where component failure could result in loss of life and/or property. For applications requiring high reliability and/or presenting an extreme operating environment, written consent and authorization from Abracon Corporation is required. Please contact Abracon Corporation for more information.

ABRACON IS
ISO9001:2008
CERTIFIED



Visit www.abracon.com for Terms & Conditions of Sale **Revised: 04.10.12**
30332 Esperanza, Rancho Santa Margarita, California 92688
tel 949-546-8000 | fax 949-546-8001 | www.abracon.com